

37KFM-24100-AMP  
instrument harness

BUSSMANN FEUC

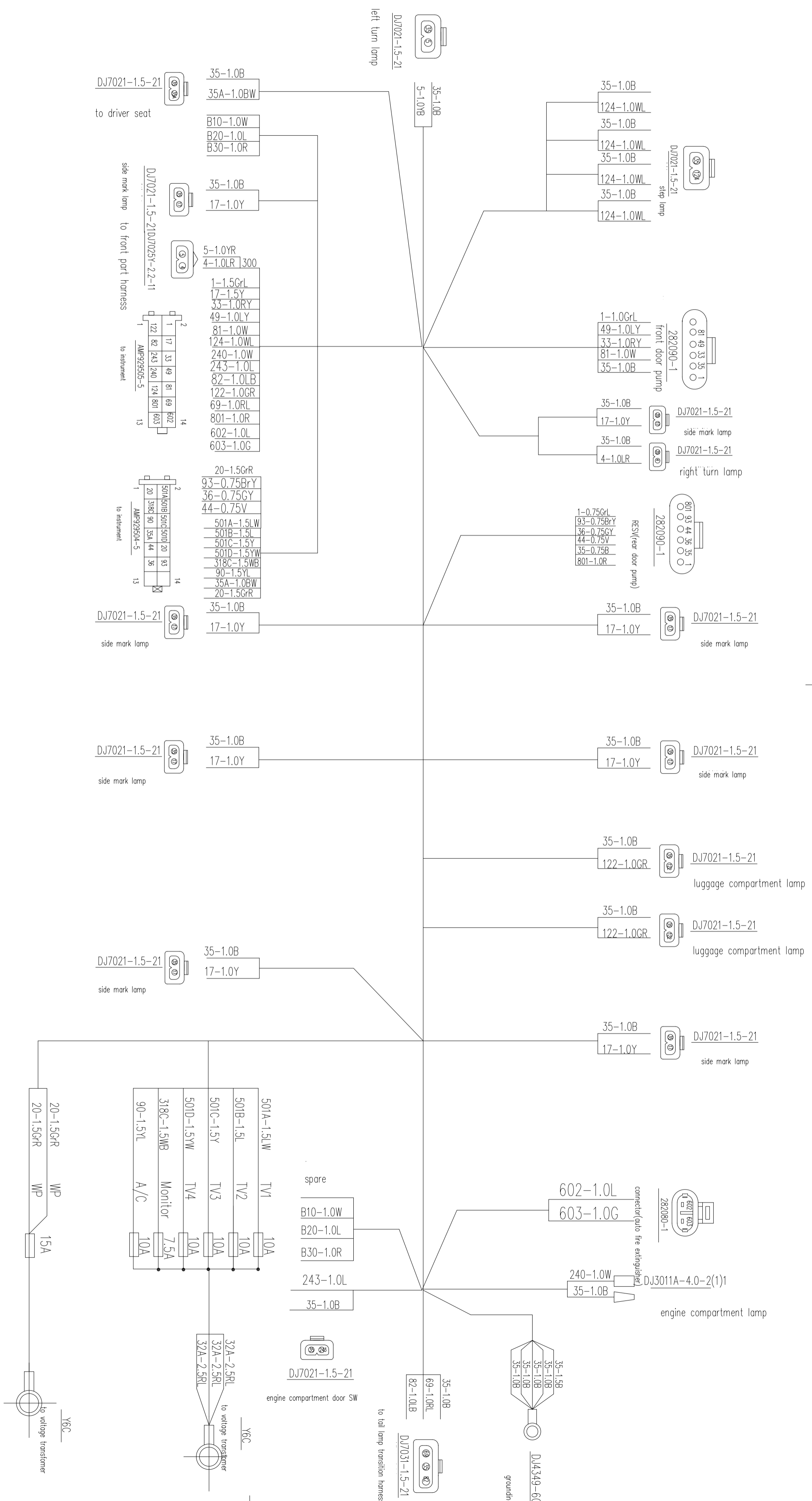

37KFM-24200

chassis harness

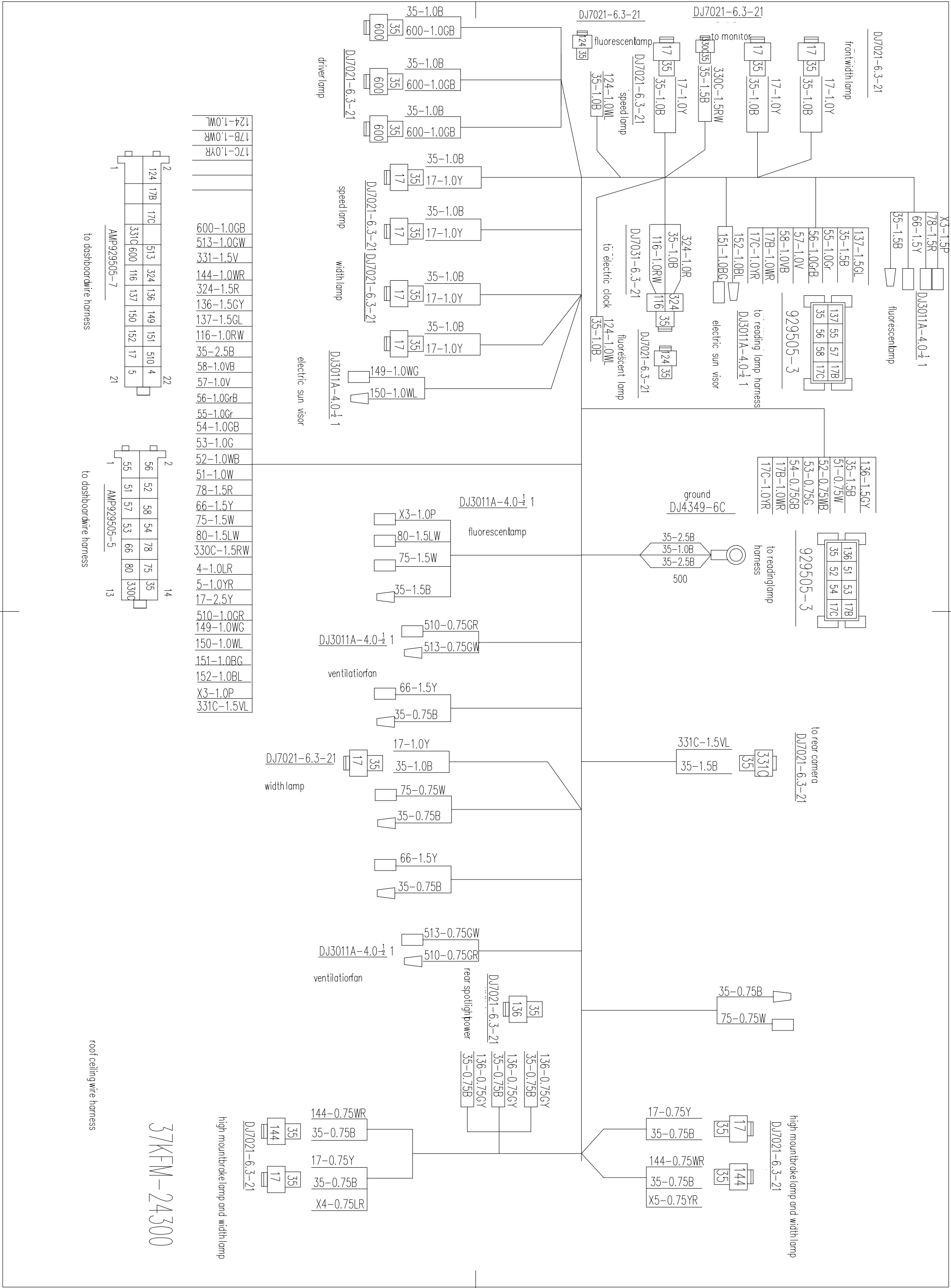

124-1.0WL	17C-1.0YR
17B-1.0WR	
600-1.0GB	513
513-1.0GW	324
331-1.5V	136
144-1.0WR	149
324-1.5R	151
136-1.5GY	510
137-1.5GL	4
116-1.0RW	5
35-2.5B	
58-1.0VB	
57-1.0V	
56-1.0GB	
55-1.0Gr	
54-1.0GB	
53-1.0G	
52-1.0WB	
51-1.0W	
78-1.5R	
66-1.5Y	
75-1.5W	
80-1.5LW	
330C-1.5RW	
4-1.0LR	
5-1.0YR	
17-2.5Y	
510-1.0GR	
149-1.0WG	
150-1.0WL	
151-1.0BG	
152-1.0BL	
X3-1.0P	
331C-1.5VL	

37KFM-24300

high mount strobe lamp and width lamp

to dashboard wire harness

to dashboard wire harness

roof ceiling wire harness

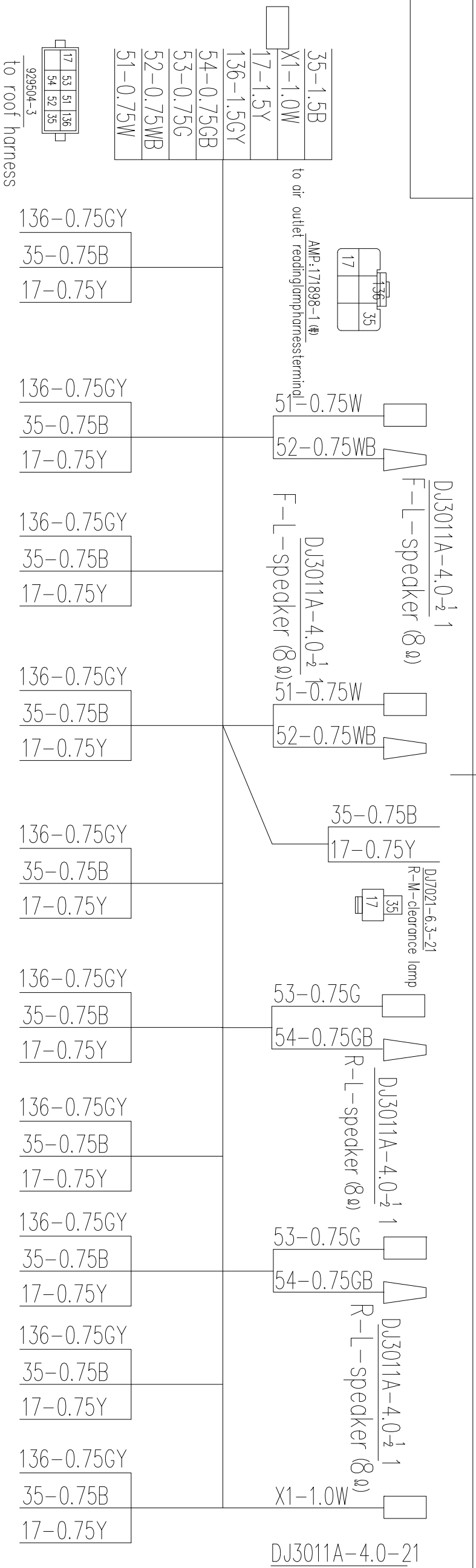

I

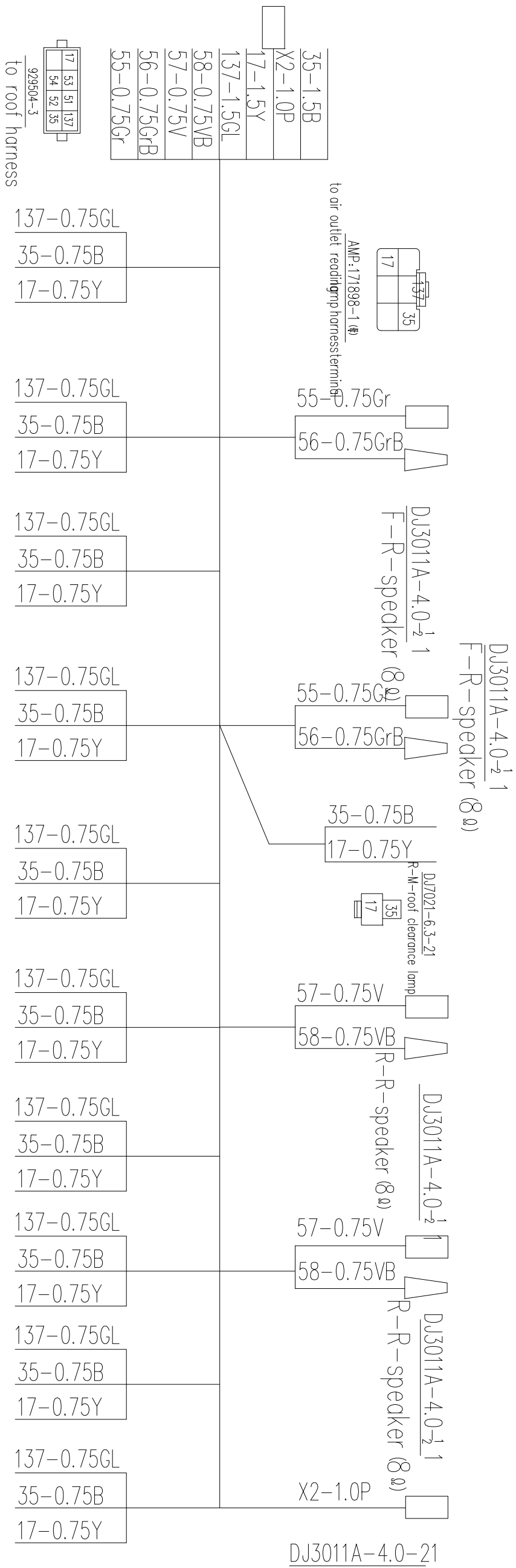

II

37KFM-24500-AMP  
reading lamp harness

DJ7025Y-2-2-21 0436605 0436001

0436001 0436605 DJ7025Y-2-2-21

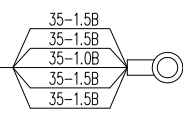
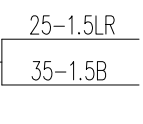
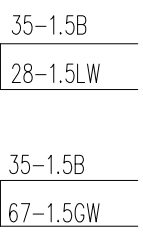
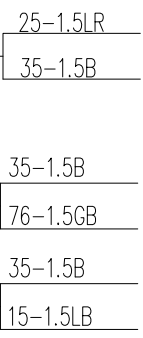
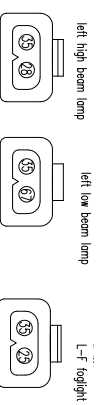
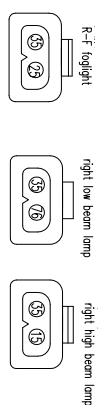

ground

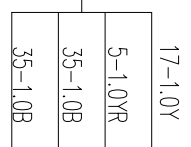
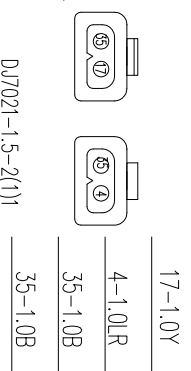

DJ7021-1-5-2(1)1

DJ7021-1-5-2(1)1

with and right turn lamp

with and left turn lamp

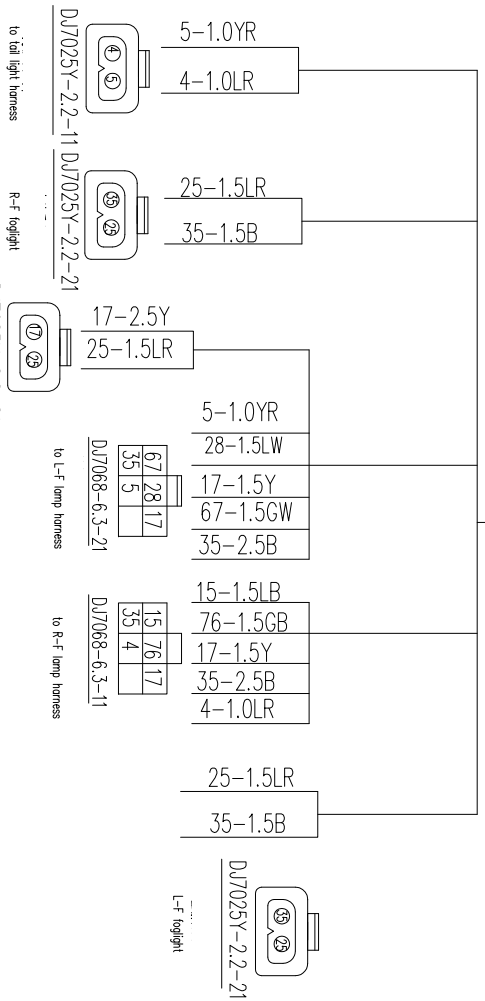

to tail light harness

R-F foglight

DJ7025Y-2-2-21

to dashboard harness

to L-F lamp harness

to R-F lamp harness

front part harness

37KFM-24400

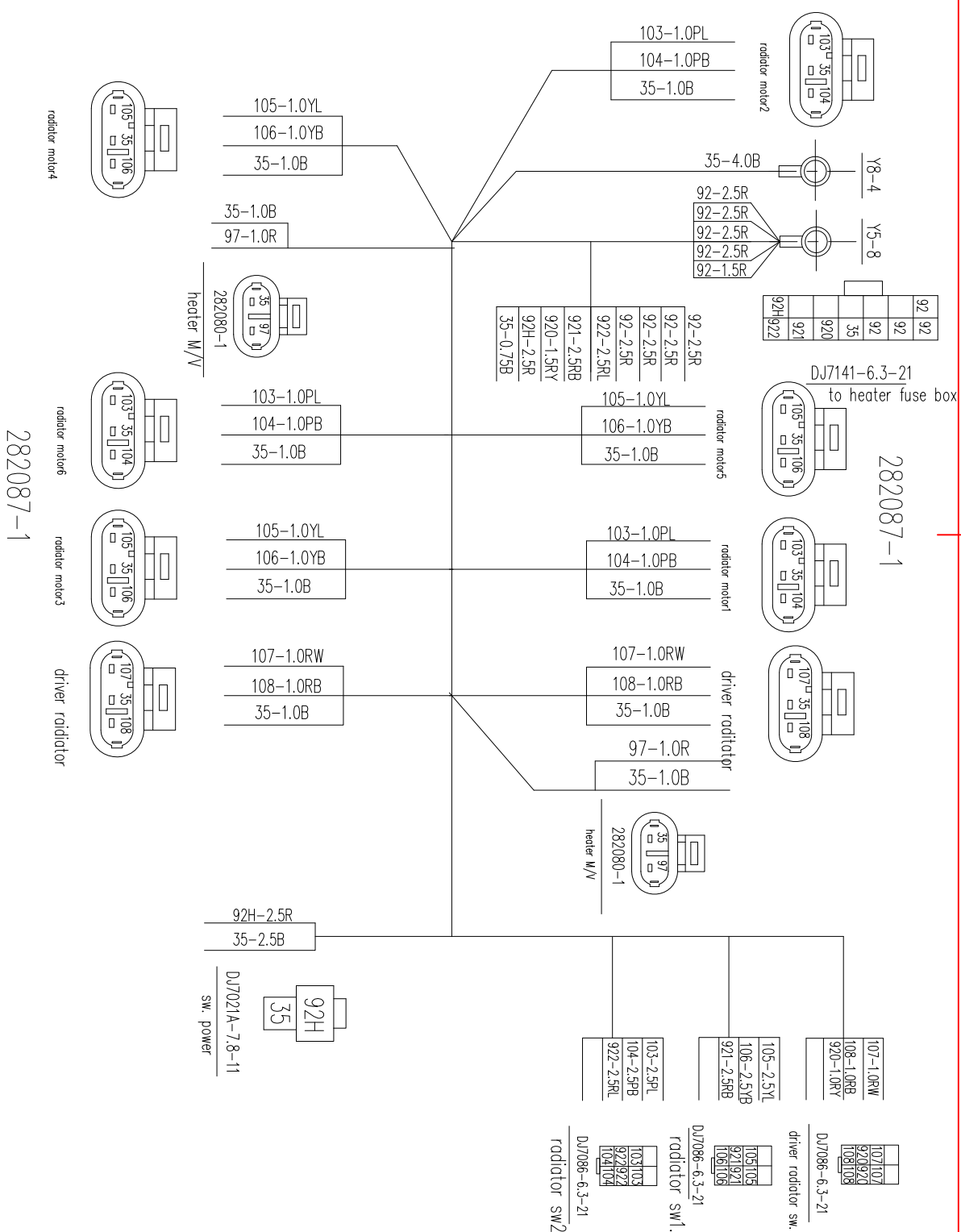

282087-1

282087-1

37KFC-24470

heater harness

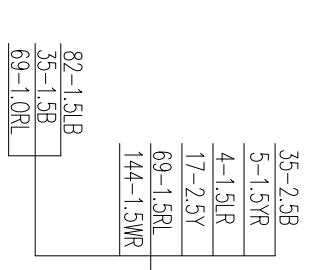

DJ7031-1.5-11  
to taillight transition wire

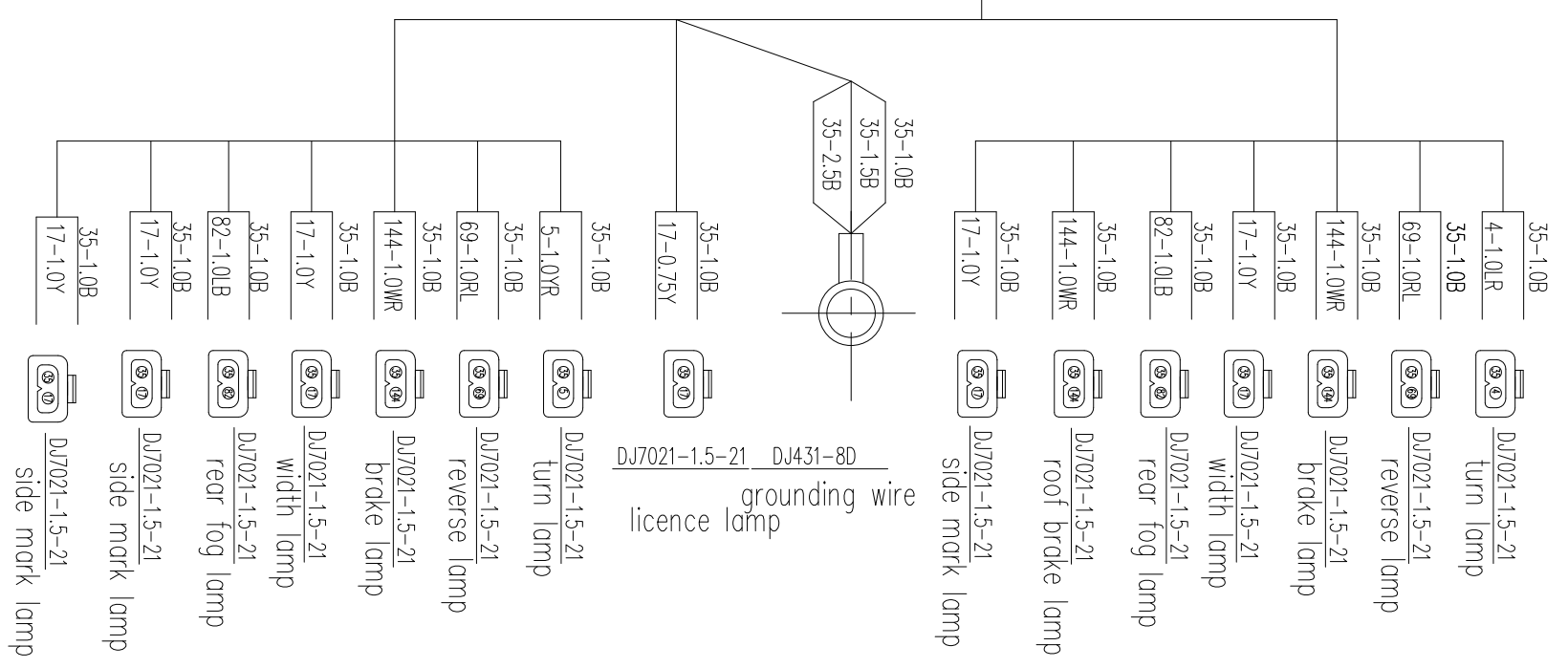

37SF1-24201WH-B  
taillight harness transition wire

602-1.0L

603-1.0G

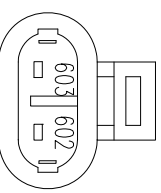

282104-1

to roof-tailight harness

602-1.0L

603-1.0G

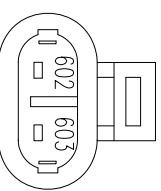

282080-1

fire extinguisher

602-1.0L

603-1.0G

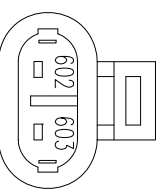

282080-1

fire extinguisher

602-1.0L

603-1.0G

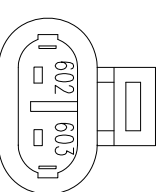

282080-1

fire extinguisher

37HL2-24211

engine COMP.T.fire extinguisher harness



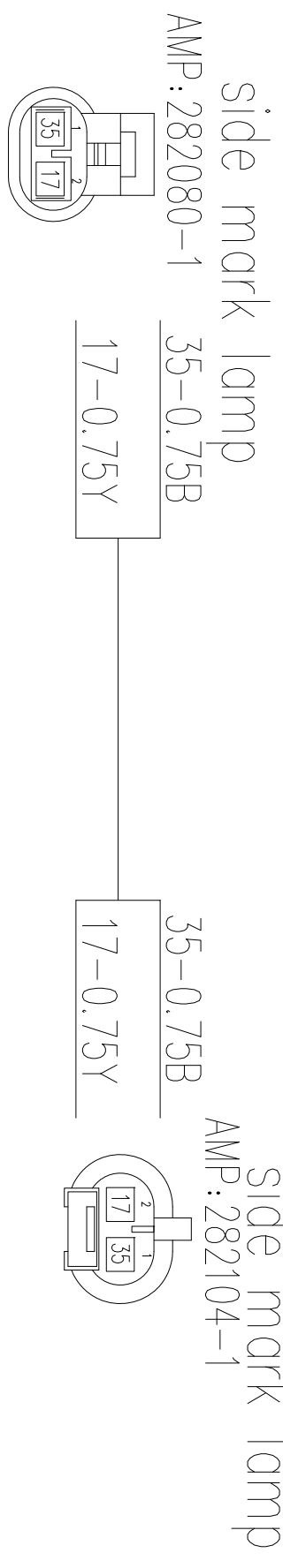

37V56-24209  
compartment door lenthen harness

put the grounding wire harness to the frame

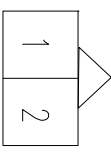
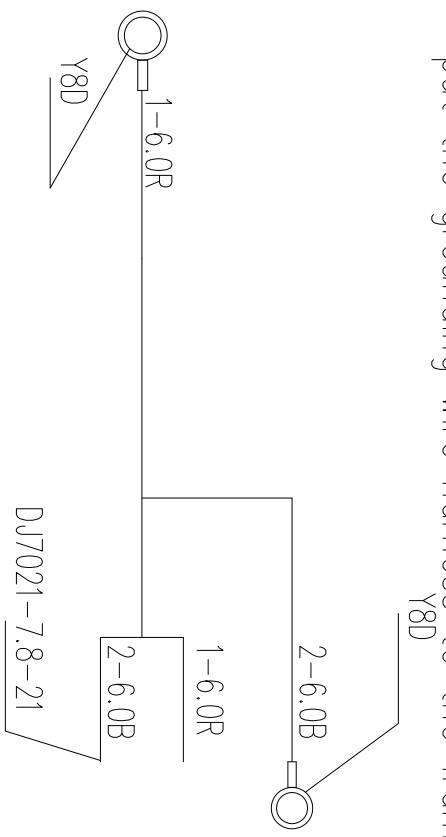

37K55-24930T

Water dispenser harness